

Digging buckets

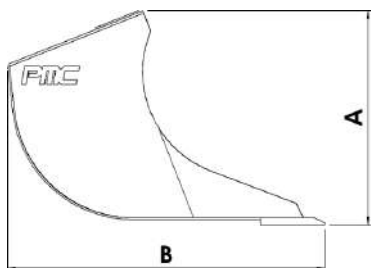

Code	Machine weight (t)	Capacity	A (mm)	B (mm)	Width (mm)	Weight	Teeth
DGB246	<1	50 L	400	530	400	35 kg	No
DGB241	<1	55 L	400	580	480	40 kg	No
DGB242	<1	55 L	400	580	480	40 kg	Yes
DGB201	<2	60 L	495	740	400	45 kg	No
DGB239	<2	60 L	495	740	400	50 kg	Yes
DGB202	<2	80 L	495	740	500	55 kg	No
DGB240	<2	80 L	495	740	500	60 kg	Yes
DGB243	<1	80 L	495	640	600	55 kg	No
DGB203	<2,5	90 L	495	740	520	65 kg	No
DGB204	<2,5	90 L	495	740	520	70 kg	Yes
DGB205	<3	100 L	495	740	600	65 kg	No
DGB206	<3	100 L	495	740	600	70 kg	Yes
DGB233	<4	180 L	665	970	600	105 kg	No
DGB234	<4	180 L	665	970	600	110 kg	Yes
DGB263	<5	210 L	670	1000	600	130 kg	No
DGB261	<7	280 L	670	1000	800	175 kg	No
DGB235	<7	300 L	775	1110	600	160 kg	No
DGB236	<7	300 L	775	1110	600	185 kg	Yes
DGB237	<7	350 L	775	1110	750	210 kg	No
DGB238	<7	350 L	775	1110	750	235 kg	Yes
DGB215	<8	400 L	775	1110	800	240 kg	No
DGB216	<8	400 L	775	1110	800	265 kg	Yes

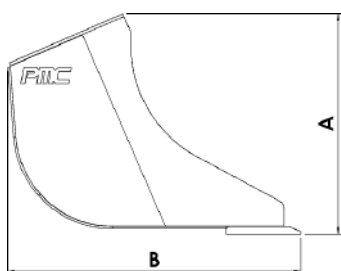

Code	Machine weight (t)	Capacity	A (mm)	B (mm)	Width (mm)	Weight	Teeth
DGB265	<4	110 L	500	740	650	75 kg	No
DGB207	<4	140 L	590	790	600	100 kg	No
DGB208	<4	140 L	590	790	600	110 kg	Yes
DGB209	<5	165 L	590	790	700	110 kg	No
DGB210	<5	165 L	590	790	700	120 kg	Yes
DGB251	-	180 L	740	800	600	165 kg	No
DGB252	-	180 L	740	800	600	195 kg	Yes



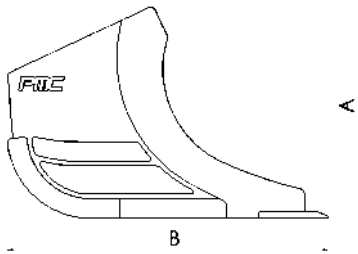

Code	Machine weight (t)	Capacity	A (mm)	B (mm)	Width (mm)	Weight Teeth	
DGB245	<13	600 L	785	1285	950	445 kg	No
DGB217	<16	650 L	925	1400	850	490 kg	No
DGB218	<16	650 L	925	1350	850	535 kg	Yes
DGB219	<18	850 L	925	1400	950	535 kg	No
DGB220	<18	850 L	925	1350	950	585 kg	Yes
DGB221	<20	1000 L	1020	1535	1000	790 kg	No
DGB222	<20	1000 L	1020	1435	1000	860 kg	Yes
DGB223	<21	1200 L	1020	1535	1200	900 kg	No
DGB224	<21	1200 L	1020	1435	1200	970 kg	Yes
DGB225	<24	1500 L	1265	1775	1400	1490 kg	No
DGB226	<24	1500 L	1265	1675	1400	1570 kg	Yes
DGB225HD	<24	1500 L	1400	1690	1400	1620 kg	No
DGB226HD	<24	1500 L	1400	1690	1400	1800 kg	Yes
DGB227	<30	1800 L	1265	1775	1600	1645 kg	No
DGB228	<30	1800 L	1265	1675	1600	1755 kg	Yes
DGB227HD	<30	1800 L	1395	1700	1600	1850 kg	No
DGB228HD	<30	1800 L	1395	1700	1600	2050 kg	Yes
DGB229	<35	2000 L	1520	1900	1600	2000 kg	No
DGB230	<35	2000 L	1520	1900	1600	2200 kg	Yes
DGB231	<40	2500 L	1570	2070	1700	2450 kg	No
DGB232	<40	2500 L	1570	2070	1700	2620 kg	Yes



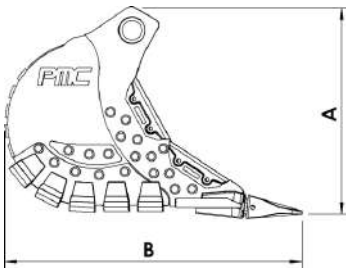

Code	Machine weight (t)	Capacity	A (mm)	B (mm)	Width (mm)	Weight	Teeth
DGB284	<52	2700 L	1700	2250	1850	~3500 kg	Yes
DGB284EX	<52	2700 L	1700	2250	1850	~3500 kg	Yes
DGB285	<60	3200 L	2110	2420	1850	4040 kg	Yes
DGB285HV	<60	3200 L	2100	2510	1850	4600 kg	Yes
DGB285EX	<60	3200 L	2100	2415	1850	4500 kg	Yes

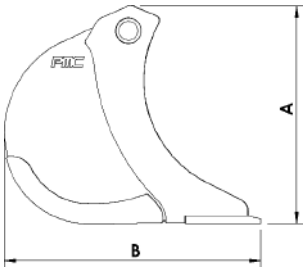

Code	Machine weight (t)	Capacity	A (mm)	B (mm)	Width (mm)	Weight	Teeth
DGB271	<24	1500 L	1250	1320	1500	1600 kg	Yes
DGB255	<40	2500 L	1530	1740	1800	2100 kg	Yes
DGB248	<46	3300 L	1700	2000	2300	~3500 kg	No
DGB250	<70	5000 L	1900	2375	2500	5000 kg	No



Digging sieve buckets

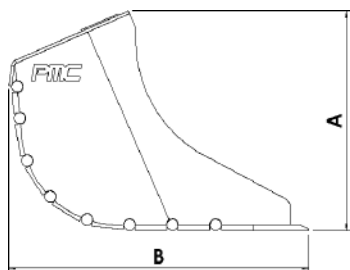

Code	Capacity	A (mm)	B (mm)	Width (mm)	Weight	Teeth
DGB205S	100 L	495	740	600	65 kg	No
DGB209S	200 L	585	800	700	120 kg	No
DGB210S	200 L	585	800	700	125 kg	Yes
DGB215S	400 L	775	1125	800	240 kg	No



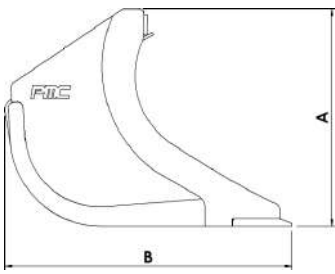

Code	Machine weight (t)	Capacity	A (mm)	B (mm)	Width (mm)	Weight	Teeth
DGB219S	<16	850 L	1015	1360	950	600 kg	No
DGB220S	<16	850 L	1015	1360	950	650 kg	Yes
DGB221S	<20	1000 L	1110	1410	1000	645 kg	No
DGB222S	<20	1000 L	1110	1410	1000	705 kg	Yes
DGB223S	<21	1200 L	1110	1410	1200	740 kg	No
DGB224S	<21	1200 L	1110	1410	1200	800 kg	Yes
DGB225S	<24	1500 L	1390	1700	1400	1515 kg	No
DGB226S	<24	1500 L	1390	1700	1400	1700 kg	Yes



Cable buckets

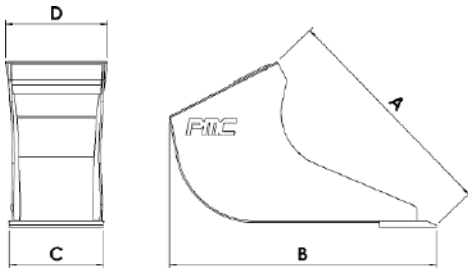

Code	Machine weight (t)	Capacity	A (mm)	B (mm)	C (mm)	D (mm)	Weight	Teeth
CAB859	<1	28 L	600	710	200	220	30 kg	No
CAB860	<1	28 L	600	710	200	220	35 kg	Yes
CAB861	<1	30 L	600	710	220	240	30 kg	No
CAB862	<1	30 L	600	710	220	240	35 kg	Yes
CAB863	<1	35 L	600	710	250	270	35 kg	No
CAB864	<1	35 L	600	710	250	270	40 kg	Yes
CAB865	<1	40 L	600	710	300	285	35 kg	No
CAB866	<1	40 L	600	710	300	285	40 kg	Yes

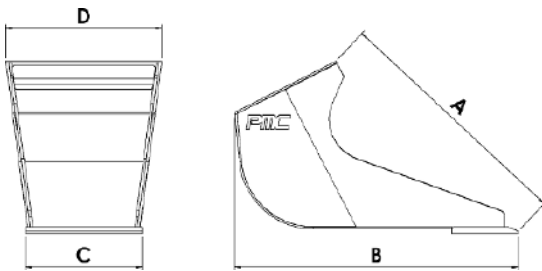

Code	Machine weight (t)	Capacity	A (mm)	B (mm)	C (mm)	D (mm)	Weight	Teeth
CAB869	<2	55 L	740	850	300	300	60 kg	No
CAB853	<3	70 L	740	850	300	420	65 kg	No
CAB854	<3	70 L	740	850	300	420	70 kg	Yes
CAB855	<3	85 L	740	850	350	465	70 kg	No
CAB856	<3	85 L	740	850	350	465	78 kg	Yes
CAB857	<4	100 L	740	850	400	520	75 kg	No
CAB858	<4	100 L	740	850	400	520	83 kg	Yes
CAB878	<8	170 L	1085	1270	350	435	130 kg	No



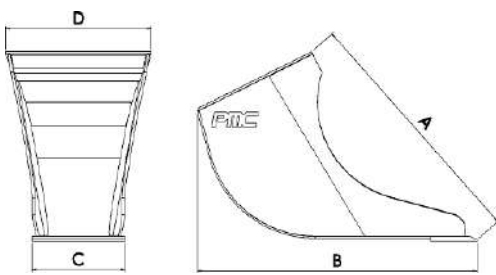

Code	Machine weight (t)	Capacity	A (mm)	B (mm)	C (mm)	D (mm)	Weight	Teeth
CAB870	<4	120 L	900	1015	300	365	85 kg	No
CAB871	<4	120 L	900	1015	300	365	95 kg	Yes
CAB847	<7	160 L	1070	1200	300	390	120 kg	No
CAB848	<7	160 L	1070	1200	300	390	130 kg	Yes
CAB849	<8	170 L	1070	1200	350	430	125 kg	No
CAB850	<8	170 L	1070	1200	350	430	135 kg	Yes
CAB851	<8	180 L	1070	1200	400	430	130 kg	No
CAB852	<8	180 L	1070	1200	400	430	140 kg	Yes
CAB867	<8	190 L	1075	1200	400	620	150 kg	No
CAB867/300	<8	190 L	1075	1200	300	620	160 kg	No
CAB868	<8	190 L	1075	1200	400	625	160 kg	Yes

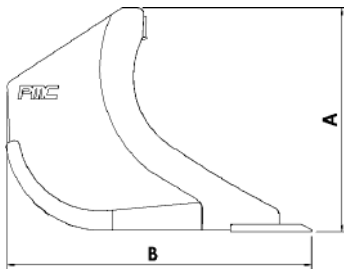

Code	Machine weight (t)	Capacity	A (mm)	B (mm)	Width (mm)	Weight	Teeth
CAB820	<12	290 L	985	1355	600	350 kg	No
CAB821	<12	290 L	985	1305	600	380 kg	Yes
CAB833	<14	360 L	985	1305	700	390 kg	No
CAB834	<14	360 L	985	1305	700	425 kg	Yes
CAB822	<16	360 L	1110	1510	600	480 kg	No
CAB823	<16	360 L	1110	1410	600	520 kg	Yes
CAB824	<16	400 L	1110	1510	600	500 kg	No
CAB825	<16	400 L	1110	1410	600	510 kg	Yes
CAB826	<16	400 L	1110	1510	700	510 kg	No
CAB827	<16	400 L	1110	1410	700	565 kg	Yes
CAB828	<16	440 L	1110	1510	700	525 kg	No
CAB829	<16	440 L	1110	1410	700	560 kg	Yes
CAB830	<18	500 L	1110	1510	800	570 kg	No
CAB831	<18	500 L	1110	1410	800	610 kg	Yes
CAB835	<18	370 L	1110	1550	600	530 kg	No
CAB836	<18	480 L	1110	1660	700	600 kg	No



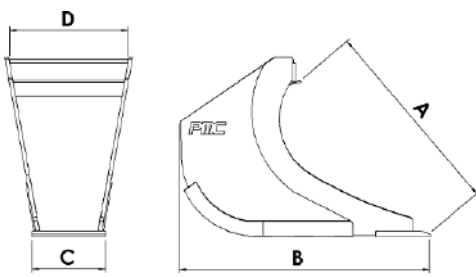

Code	Machine weight (t)	Capacity	A (mm)	B (mm)	C (mm)	D (mm)	Weight
CAB819	<12	240 L	1100	1355	400	495	350 kg
CAB818	<12	290 L	1085	1355	400	700	380 kg
CAB810	<20	360 L	1490	1845	400	500	465 kg
CAB811	<21	390 L	1490	1845	400	600	500 kg
CAB812	<22	430 L	1490	1845	400	700	530 kg



Tilting planning buckets

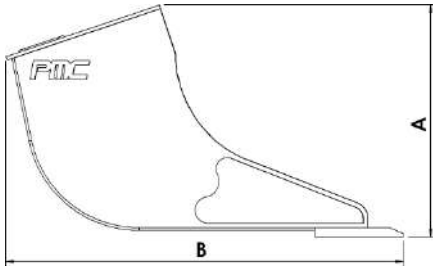

Code	Machine weight (t)	Capacity	A (mm)	B (mm)	Width (mm)	Weight Cylinders
HPB103	<1	40 L	300	445	800	70 kg 1 (H)
HPB104	<2	70 L	315	515	1000	100 kg 1 (H)
HPB108	<3	90 L	315	515	1200	110 kg 1 (H)
HPB105	<4	130 L	380	585	1000	105 kg 1 (H)
HPB106	<5	180 L	390	660	1200	170 kg 1 (H)
HPB110	<5	220 L	390	660	1300	180 kg 1 (H)
HPB107	<6	280 L	520	895	1200	255 kg 2 (H)
HPB109	<7	300 L	520	895	1300	265 kg 2 (H)
HPB111	<8	400 L	520	895	1500	280 kg 2 (H)

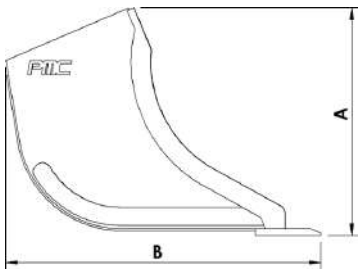

Code	Machine weight (t)	Capacity	A (mm)	B (mm)	Width (mm)	Weight Cylinders
HPB113	<8	300 L	695	960	1000	310 kg 1 (V)
HPB114	<8	370 L	695	960	1200	340 kg 1 (V)
HPB115	<8	410 L	695	960	1300	355 kg 1 (V)



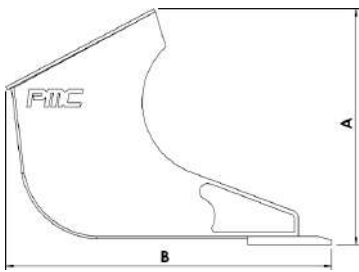

Code	Machine weight (t)	Capacity	A (mm)	B (mm)	Width (mm)	Weight	Cylinders
HPB116	<7	180 L	560	770	1000	215 kg	2 (H)
HPB117	<7	220 L	560	770	1200	250 kg	2 (H)
HPB118	<8	270 L	560	770	1500	280 kg	2 (H)

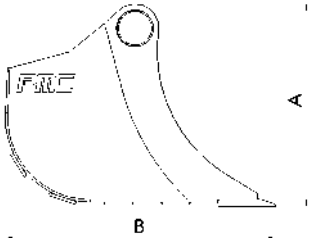

Code	Machine weight (t)	Capacity	A (mm)	B (mm)	Width (mm)	Weight	Cylinders
HPB131	<16	550 L	650	860	2000	800 kg	2 (H)
HPB127	<16	700 L	712	950	2000	830 kg	2 (H)
HPB128	<18	900 L	712	950	2500	950 kg	2 (H)
HPB129	<18	950 L	840	1075	1800	860 kg	2 (H)



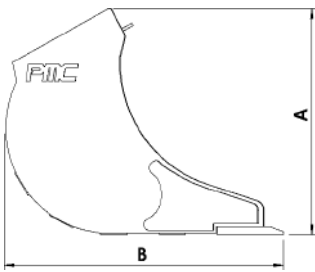

Code	Machine weight (t)	Capacity	A (mm)	B (mm)	Width (mm)	Weight Cylinders	
HPB119	<16	700 L	840	1055	1500	730 kg	1 (V)
HPB120	<20	900 L	845	1055	1750	890 kg	1 (V)
HPB121	<20	900 L	845	1055	1750	950 kg	2 (V)
HPB130	<24	1200 L	820	1045	3000	1525 kg	2 (V)
HPB122	<24	1200 L	900	1200	2000	1330 kg	2 (V)
HPB123	<30	1500 L	1145	1395	2000	2000 kg	2 (V)
HPB124	<30	2000 L	1365	1650	2000	2495 kg	2 (V)

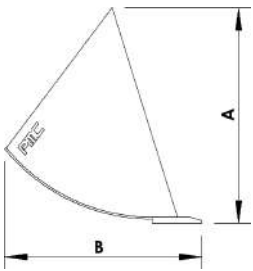

Code	Machine weight (t)	Capacity	A (mm)	B (mm)	Width (mm)	Weight Cylinders	
HPB125	<16	700 L	870	800	2000	750 kg	2 (H)
HPB126	<20	900 L	870	800	2500	770 kg	2 (H)
HPB160	<24	1200 L	870	800	3000	860 kg	2 (H)



Static planning bucket

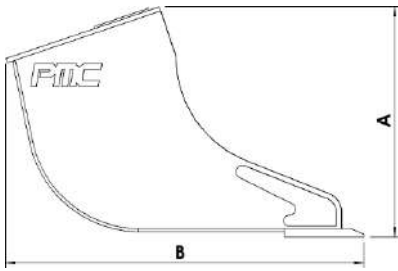

Code	Machine weight (t)	Capacity	A (mm)	B (mm)	Width (mm)	Weight
SPB159	<1	40 L	300	445	800	50 kg
SPB134	<2	70 L	315	510	1000	55 kg
SPB138	<3	90 L	315	510	1200	65 kg
SPB135	<4	90 L	385	595	1000	75 kg
SPB136	<5	180 L	435	675	1200	120 kg
SPB140	<5	220 L	390	660	1300	125 kg
SPB137	<6	280 L	520	890	1200	175 kg
SPB139	<7	300 L	520	890	1300	195 kg
SPB141	<8	400 L	520	890	1500	210 kg

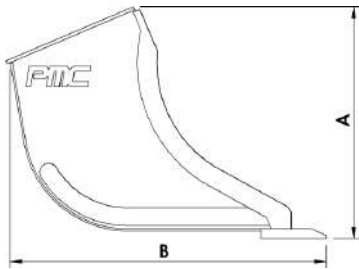

Code	Machine weight (t)	Capacity	A (mm)	B (mm)	Width (mm)	Weight
SPB143	<7	300 L	700	965	1000	185 kg
SPB144	<8	400 L	700	965	1200	215 kg
SPB145	<8	500 L	700	965	1300	230 kg



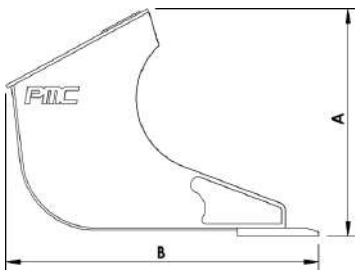

Code	Machine weight (t)	Capacity	A (mm)	B (mm)	Width (mm)	Weight
SPB146	<7	180 L	560	770	1000	150 kg
SPB147	<7	220 L	560	770	1200	165 kg
SPB148	<8	270 L	560	770	1500	210 kg

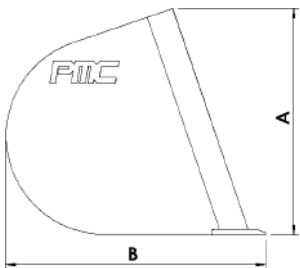

Code	Machine weight (t)	Capacity	A (mm)	B (mm)	Width (mm)	Weight
SPB132	<13	1000 L	865	975	2000	440 kg

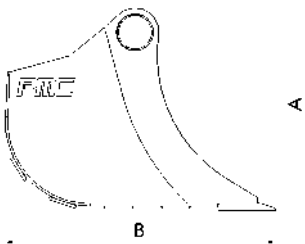

Code	Machine weight (t)	Capacity	A (mm)	B (mm)	Width (mm)	Weight
SPB161	<16	550 L	650	865	2000	515 kg
SPB157	<16	700 L	712	950	2000	550 kg
SPB158	<18	900 L	712	950	2500	665 kg
SPB162	<20	1050 L	712	1000	3000	815 kg



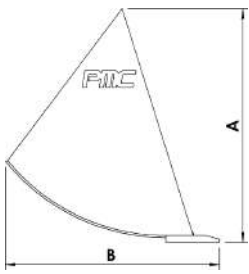

Code	Machine weight (t)	Capacity	A (mm)	B (mm)	Width (mm)	Weight
SPB155	<16	700 L	870	800	2000	515 kg
SPB156	<20	900 L	870	800	2500	610 kg

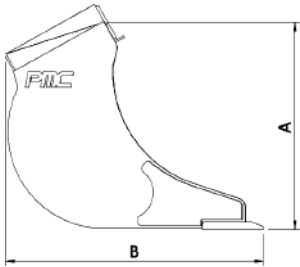

Code	Machine weight (t)	Capacity	A (mm)	B (mm)	Width (mm)	Weight
SPB149	<16	700 L	840	1050	1500	540 kg
SPB150	<20	900 L	845	1050	1750	660 kg
SPB152	<24	1200 L	910	1200	2000	1135 kg
SPB153	<30	1500 L	1145	1390	2000	1610 kg
SPB154	<38	2000 L	1365	1650	2000	1760 kg



Rotator buckets

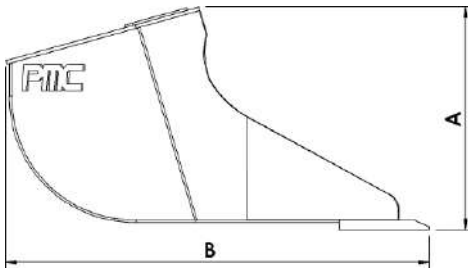

Code	Machine weight (t)	Capacity	A (mm)	B (mm)	Width (mm)	Weight
RTB188	<1,5	70 L	370	705	800	56 kg
RTB189	<2	90 L	370	705	900	65 kg
RTB190	<3	120 L	370	705	1000	75 kg
RTB191	<3,5	140 L	370	705	1100	85 kg

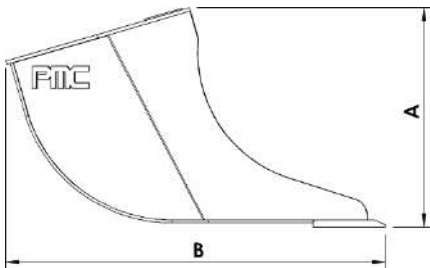

Code	Machine weight (t)	Capacity	A (mm)	B (mm)	Width (mm)	Weight
RTB178	<4	150 L	465	850	1000	105 kg
RTB179	<5	200 L	465	850	1100	115 kg
RTB180	<6	250 L	465	850	1200	125 kg
RTB181	<6	300 L	465	850	1300	135 kg
RTB194	<7	320 L	605	1045	1300	240 kg
RTB193	<8	370 L	605	1045	1400	260 kg
RTB192	<8	420 L	605	1045	1500	275 kg
RTB182	<8	400 L	705	1105	1300	250 kg
RTB183	<10	450 L	705	1105	1400	260 kg
RTB184	<12	500 L	705	1105	1500	270 kg



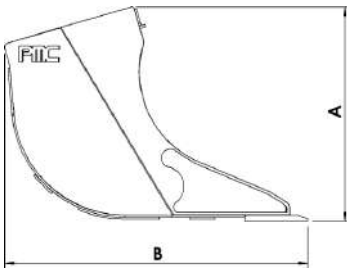

Code	Machine weight (t)	Capacity	A (mm)	B (mm)	Width (mm)	Weight
RTB185	<15	500 L	855	1210	1300	450 kg
RTB186	<16	700 L	855	1210	1500	530 kg
RTB195	<16	700 L	855	1210	1500	460 kg
RTB187	<20	900 L	860	1210	1750	650 kg

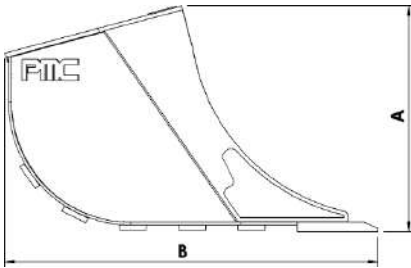

Code	Machine weight (t)	Capacity	A (mm)	B (mm)	Width (mm)	Weight
RTB197	<16	600 L	715	1285	1400	450 kg
RTB196	<16	650 L	715	1285	1600	550 kg
RTB176	<20	900 L	785	1280	1750	750 kg
RTB198	<22	1100 L	840	1390	1800	780 kg
RTB177	<24	1200 L	1025	1620	1800	950 kg
RTB199	<28	1500 L	1000	1390	1900	1100 kg



Rotator sieve buckets

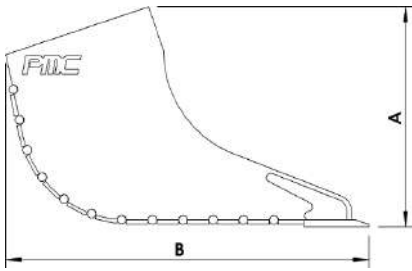

Code	Machine weight (t)	Capacity	A (mm)	B (mm)	Width (mm)	Weight
SPB159S	<1	40 L	300	450	800	55 kg
SPB138S	<3	90 L	310	500	1200	85 kg
SPB136S	<5	180 L	510	840	1200	190 kg
SPB139S	<7	300 L	515	860	1300	250 kg
SPB144S	<8	400 L	700	1010	1200	300 kg
SPB158S	18	820 L	745	935	2500	650 kg

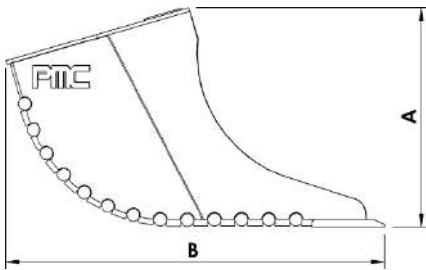

Code	Machine weight (t)	Capacity	A (mm)	B (mm)	Width (mm)	Weight
RTB181S	<6	300 L	520	855	1300	200 kg
RTB193S	<8	370 L	605	1046	1400	300 kg
RTB182S	<8	400 L	705	1105	1300	300 kg
RTB183S	<10	450 L	705	1105	1400	330 kg
RTB184S	<12	500 L	705	1105	1500	370 kg
RTB195S	<16	700 L	870	1230	1500	470 kg
RTB187S	<20	900 L	950	1230	1750	650 kg

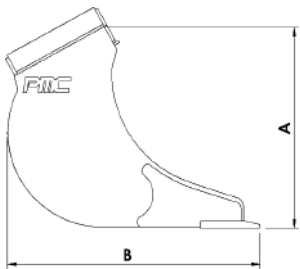

Code	Machine weight (t)	Capacity	A (mm)	B (mm)	Width (mm)	Weight
SPB149S	<16	700 L	930	1055	1500	600 kg
SPB150S	<20	900 L	930	1060	1750	680 kg
SPB152S	<24	1250 L	940	1200	2000	1040 kg



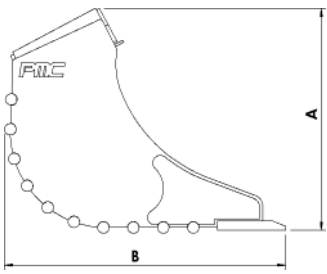

Code	Machine weight (t)	Capacity	A (mm)	B (mm)	Width (mm)	Weight
SPB150SH	<20	900 L	930	1080	1750	690 kg
SPB152SH	<24	1250 L	975	1230	2000	1100 kg



V-line buckets

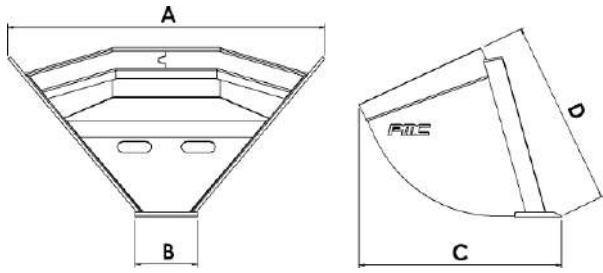

Code	Machine weight (t)	Capacity	A (mm)	B (mm)	C (mm)	D (mm)	Weight	Teeth
VLB319	<1	50 L	700	200	535	500	40 kg	No
VLB320	<1	50 L	700	200	535	500	46 kg	Yes
VLB317	<2	100 L	950	200	445	410	40 kg	No
VLB318	<2	100 L	950	200	445	410	46 kg	Yes
VLB309	<4	150 L	1300	200	650	540	64 kg	No
VLB310	<4	150 L	1300	200	650	540	70 kg	Yes
VLB366	<4	150 L	1345	200	650	600	100 kg	No
VLB301	<6	300 L	1700	200	865	850	180 kg	No
VLB302	<6	300 L	1700	200	865	850	186 kg	Yes
VLB303	<7	350 L	1800	200	900	950	-	No
VLB304	<7	350 L	1800	200	900	950	-	Yes
VLB305	<8	400 L	2100	320	905	1005	300 kg	No
VLB306	<8	400 L	2100	320	905	1005	315 kg	Yes
VLB307	<8	450 L	2200	320	960	1085	320 kg	No
VLB308	<8	450 L	2200	320	960	1085	335 kg	Yes

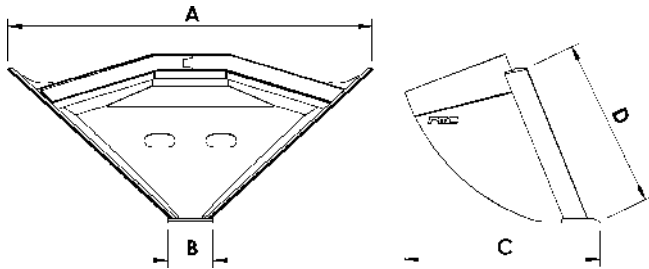

Code	Machine weight (t)	Capacity	A (mm)	B (mm)	C (mm)	D (mm)	Weight	Teeth
VLB321	<13	550 L	2380	300	1275	1100	400 kg	No
VLB322	<13	550 L	2380	300	1275	1100	420 kg	Yes



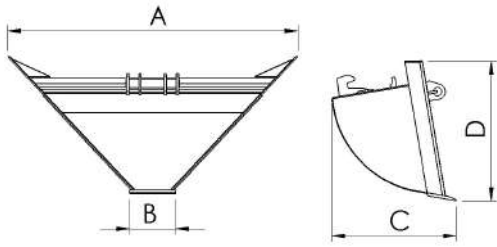

Code	Machine weight (t)	Capacity	A (mm)	B (mm)	C (mm)	D (mm)	Weight	Teeth
VLB311	<18	750 L	2300	380	1150	1350	650 kg	No
VLB312	<18	750 L	2300	380	1150	1350	650 kg	Yes
VLB313	<21	900 L	2400	380	1200	1400	735 kg	No
VLB314	<21	900 L	2400	380	1200	1400	735 kg	Yes
VLB315	<26	1200 L	2500	380	1250	1450	-	No
VLB316	<26	1200 L	2500	380	1250	1450	-	Yes
VLB399	-	2000 L	4100	400	1250	1350	1400 kg	No

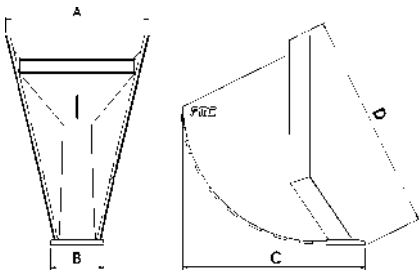

Code	Machine weight (t)	Capacity	A (mm)	B (mm)	C (mm)	D (mm)	Weight
VLB331	<7	150 L	550	270	970	1100	165 kg
VLB332	<13	250 L	800	300	1350	1300	220 kg
VLB333	<14	300 L	900	350	1350	1300	-
VLB334	<20	550 L	1085	400	1400	1600	490 kg
VLB335	<21	650 L	1300	500	1550	1500	630 kg
VLB336	<26	800 L	1150	500	1550	1800	650 kg



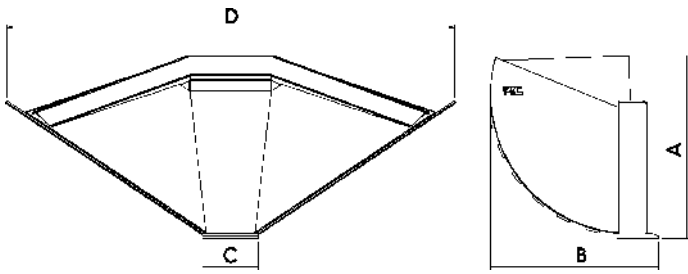

Code	Machine weight (t)	Capacity	A (mm)	B (mm)	C (mm)	D (mm)	Profile	Weight	Cylinders
VLB340	<8	300 L	720	660	400	2100	1:1,5	340 kg	1 (V)
VLB345	16	600 L	1185	1025	300	2360	1:1	480 kg	No
VLB341	<20	700 L	1030	1020	400	2800	1:1,5	560 kg	No
VLB343	<20	700 L	1030	1020	400	2800	1:1,5	855 kg	1 (V)
VLB342	<20	700 L	1040	1015	400	2980	1:2	645 kg	No
VLB323	<20	700 L	1040	1015	400	2980	1:2	915 kg	1 (V)
VLB344	<26	1100 L	1254	1110	400	3300	1:1,5	1100 kg	1 (V)



U-line buckets

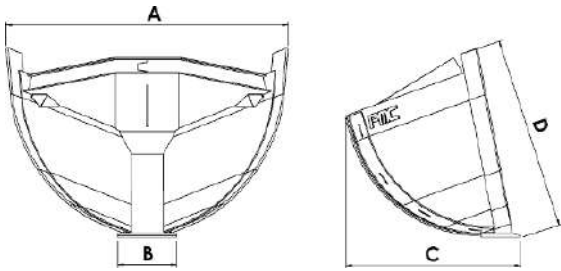

Code	Machine weight (t)	Capacity	A (mm)	B (mm)	C (mm)	D (mm)	Weight	Teeth
ULB351	<7	300 L	1500	200	800	850	180 kg	No
ULB352	<7	300 L	1500	200	800	850	190 kg	Yes
ULB353	<8	350 L	1600	200	900	950	200 kg	No
ULB354	<8	350 L	1600	200	900	950	210 kg	Yes
ULB357	<9	450 L	1700	375	1000	1150	360 kg	No
ULB358	<9	450 L	1700	375	1000	1150	375 kg	Yes
ULB359	<13	550 L	1800	375	1100	1340	400 kg	No
ULB360	<13	550 L	1800	375	1100	1340	420 kg	Yes

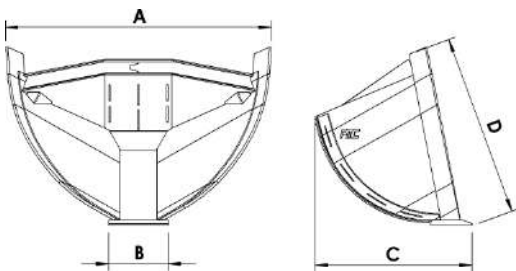

Code	Machine weight (t)	Capacity	A (mm)	B (mm)	C (mm)	D (mm)	Weight	Teeth
ULB361	<18	750 L	1950	435	1150	1350	570 kg	No
ULB362	<18	750 L	1950	435	1150	1350	600 kg	Yes
ULB363	<21	900 L	2000	435	1200	1400	665 kg	No
ULB364	<21	900 L	2000	435	1200	1400	690 kg	Yes
ULB365	<26	1200 L	2150	435	1250	1450	-	No
ULB366	<26	1200 L	2160	435	1250	1450	-	Yes



Light material buckets

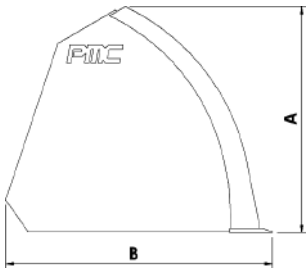

Code	Capacity	A (mm)	B (mm)	Width (mm)	Weight
LMB415	2000 L	1055	1240	2500	620 kg
LMB416	2350 L	1135	1320	2550	670 kg
LMB417	2600 L	1190	1370	2600	770 kg
LMB418	3200 L	1310	1500	2600	850 kg
LMB419	3750 L	1420	1615	2600	910 kg
LMB420	4100 L	1485	1715	2600	1100 kg

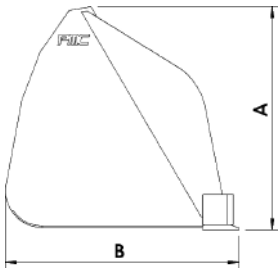

Code	Capacity	A (mm)	B (mm)	Width (mm)	Weight
LMB421	5400 L	1695	1750	3000	1500 kg
LMB427	6000 L	1830	1915	3000	2000 kg
LMB423	7000 L	1975	2070	3200	2250 kg
LMB425	9000 L	2070	2170	3600	2450 kg



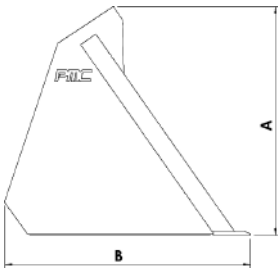

Code	Capacity	A (mm)	B (mm)	Width (mm)	Weight
LMB410	450 L	760	775	1500	190kg
LMB411	600 L	760	775	2000	220 kg
LMB412	800 L	845	845	2100	265 kg
LMB413	1200 L	945	995	2200	340 kg
LMB414	1600 L	1050	1105	2300	445 kg
LMB403	1800 L	1125	1240	2400	555 kg
LMB426	2400 L	1240	1330	2600	750 kg
LMB424	4000 L	1585	1690	2700	1210 kg

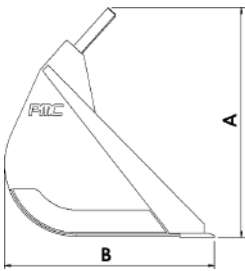

Code	Capacity	A (mm)	B (mm)	Width (mm)	Weight
LMB429	2300 L	1325	1210	2500	630 kg
LMB402	4000 L	1520	1610	2750	1100 kg

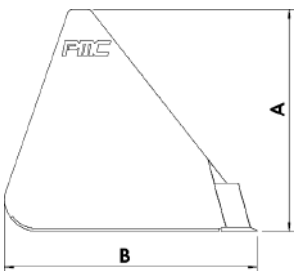

Code	Capacity	A (mm)	B (mm)	Width (mm)	Weight
LMB490/1400	800 L	920	1050	1400	180 kg
LMB490/1600	900 L	920	1050	1600	195 kg
LMB490/1800	1000 L	920	1050	1800	215 kg
LMB490/2000	1200 L	920	1050	2000	230 kg
LMB490/2200	1300 L	920	1050	2200	245 kg
LMB490/2400	1450 L	920	1050	2400	260 kg



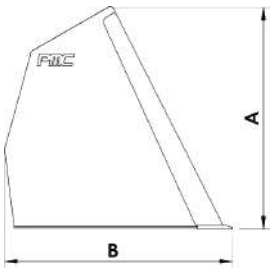

Code	Capacity	A (mm)	B (mm)	Width (mm)	Weight
LMB476	1350 L	1030	1005	2050	325 kg
LMB4762	2350 L	1290	1245	2300	690 kg
LMB4763	3000 L	1345	1270	2700	740 kg
LMB4764	4000 L	1495	1425	2800	900 kg
LMB4765	5000 L	1580	1615	2900	1020 kg



Gravel buckets

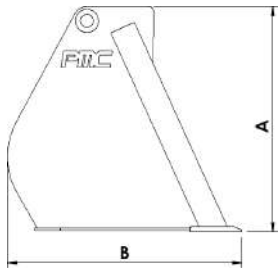

Code	Capacity	A (mm)	B (mm)	Width (mm)	Weight	Teeth
GRB435	1000 L	875	900	2100	380 kg	No
GRB437	1100 L	875	900	2200	400 kg	No
GRB439	1200 L	875	900	2300	420 kg	No

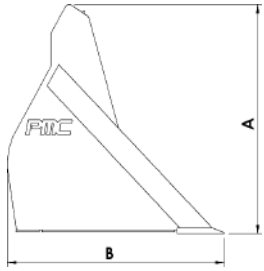

Code	Capacity	A (mm)	B (mm)	Width (mm)	Weight	Teeth
GRB441	1000 L	975	925	2300	520 kg	No
GRB443	1040 L	975	925	2400	540 kg	No
GRB445	1075 L	975	925	2500	555 kg	No



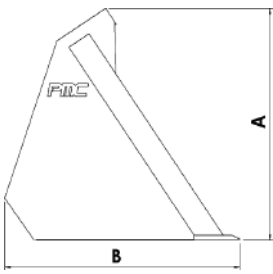

Code	Capacity	A (mm)	B (mm)	Width (mm)	Weight	Teeth
GRB430	450 L	760	780	1500	180 kg	No
GRB431	650 L	800	755	2000	240 kg	No
GRB432	800 L	850	865	2100	330 kg	No
GRB433	1200 L	955	1050	2200	460 kg	No
GRB434	1700 L	1055	1155	2300	560 kg	No

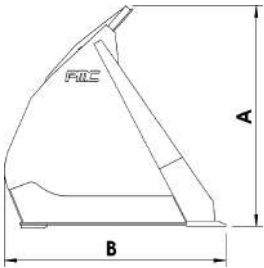

Code	Capacity	A (mm)	B (mm)	Width (mm)	Weight	Teeth
GRB447	1800 L	1125	1000	3000	800 kg	No
GRB449	2100 L	1130	1125	3000	870 kg	No
GRB451	2300 L	1200	1165	3000	1000 kg	No
GRB453	3000 L	1285	1330	3000	1250 kg	No
GRB455	3500 L	1365	1475	3000	1450 kg	No
GRB457	4000 L	1365	1475	3200	1500 kg	No
GRB459	4500 L	1610	1530	3200	1850 kg	No
GRB461	5000 L	1685	1685	3200	2000 kg	No
GRB463	5500 L	1620	1920	3200	~1900 kg	No
GRB465	6000 L	1725	2030	3200	2500 kg	No

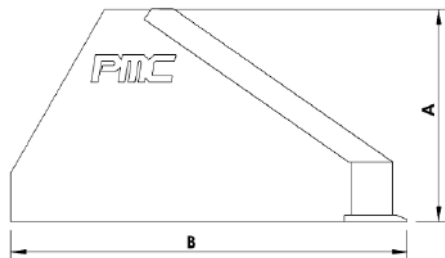

Code	Capacity	A (mm)	B (mm)	Width (mm)	Weight	Teeth
GRB490	450 L	505	940	1700	235 kg	No



Frontal planning buckets

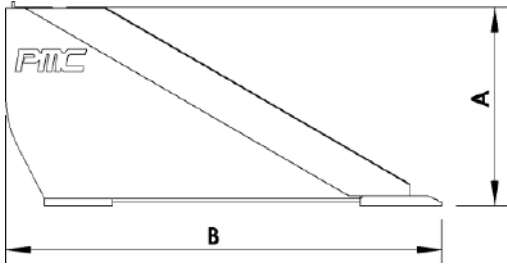

Code	Capacity	A (mm)	B (mm)	Width (mm)	Weight
FPB476/2100	670 L	510	1252	2100	370 kg
FPB474	1000 L	525	1245	2000	485 kg
FPB475	1200 L	600	1245	2500	680 kg
FPB489/2750	1900 L	725	1600	2750	1150 kg
FPB489	2000 L	725	1600	3000	1250 kg



High dumping bucket

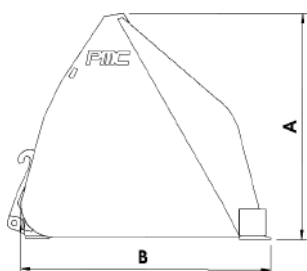

Code	Capacity	A (mm)	B (mm)	Width (mm)	Weight
HDB480	1000 L	890	1015	2350	600 kg
HDB481	1500 L	1110	1185	2350	960 kg
HDB482	2000 L	1125	1255	2350	985 kg
HDB483	2500 L	1400	1355	2500	~1000 kg
HDB484	2800 L	1395	1450	2800	1250 kg
HDB485	4000 L	1515	1565	3000	1750 kg
HDB486	5000 L	1695	1800	3000	2115 kg
HDB487	6000 L	1830	1915	3200	2500 kg
HDB488	8000 L	1975	2100	3200	2650 kg
HDB490	10000 L	2145	2370	3200	3400 kg
HDB491	12000 L	2290	2518	3400	4000 kg

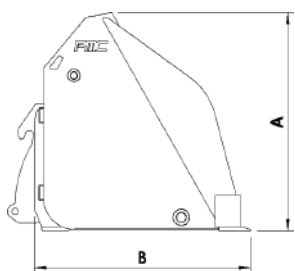

Code	Capacity	A (mm)	B (mm)	Width (mm)	Weight
HDB470	5000 L	1720	1695	3200	2300 kg
HDB471	6000 L	1800	1796	3200	2500 kg
HDB472	8000 L	1975	2055	3200	3050 kg



Frontal buckets with grabber

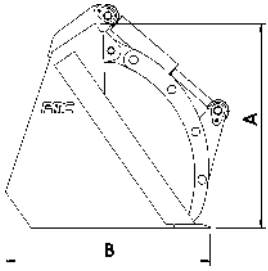

Code	Capacity	A (mm)	B (mm)	Width (mm)	Weight
BWG493	1000 L	845	840	2100	450 kg

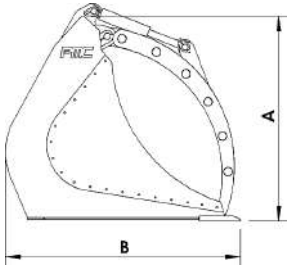

Code	Capacity	A (mm)	B (mm)	Width (mm)	Weight
BWG491	2000 L	1145	1265	2500	1200 kg
BWG492	3000 L	1325	1425	3000	1500 kg



Universal buckets

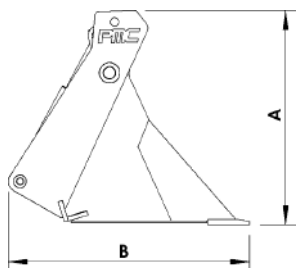

Code	Capacity	A (mm)	B (mm)	Width (mm)	Teeth	Weight
UNB493	300 L	760	855	1200	No	210 kg
UNB494	1000 L	1030	1150	2100	No	650 kg
UNB495	1000 L	1030	1150	2100	Yes	700 kg
UNB496	1300 L	1030	1150	2500	No	860 kg
UNB497	1300 L	1030	1150	2500	Yes	900 kg
UNB498	2000 L	1230	1370	2500	No	900 kg
UNB499	2000 L	1230	1370	2500	Yes	950 kg



Sieve Loader buckets

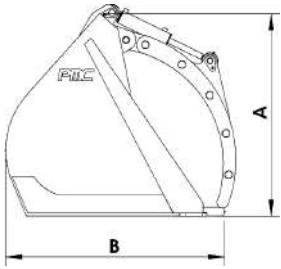

Code	Capacity	A (mm)	B (mm)	Width (mm)
GRB449-SGR	1400 L	1130	1200	2600

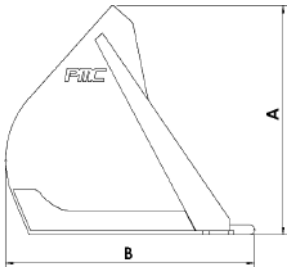

Code	Capacity	A (mm)	B (mm)	Width (mm)
GRB447-S	1300 L	1130	1200	2000
GDB449-S	1400 L	1130	1200	2600



Frontal quick couplers

Code	Coupler	Locking system	Weight
FQC670	Komatsu WB 97-5	Mechanical	140 kg
FQC671	Volvo 120	Hydraulic	200 kg
FQC672	Volvo 120	Mechanical	200 kg
ADP25	Euro8	Mechanical	100 kg
ADP31	Manitou	Mechanical	145 kg



Code	Coupler	Lock	Weight	Comments
FQC673	Volvo L50-120	Hydraulic	~550 kg	
FQC675	Volvo L150-180	Hydraulic	~750 kg	
FQC676	Volvo L150-180	Mechanical	~400 kg	Light version



Tilting quick couplers

Code	Coupler	Reccomended machine weight (t)	Locking system	Cylinders	Tilt angle	Weight
DQC640	NTP10	13-22	Mechanical	1	45°+45°	455 kg
DQC641	NTP10	13-22	Hydraulic	1	45°+45°	460 kg
DQC642	NTP10	13-22	Mechanical	2	45°+45°	520 kg
DQC643	NTP10	13-22	Hydraulic	2	45°+45°	530 kg
DQC644	NTP20	18-29	Mechanical	2	45°+45°	615 kg
DQC645	NTP20	18-29	Hydraulic	2	45°+45°	620 kg
DQC646	NTP30	-	Mechanical	2	45°+45°	780 kg



Code	Coupler	Reccomended machine weight (t)	Locking system	Tilt angle	Cylinders	Weight
DQC650	S-30/150	0,5-2	Mechanical	40°+40°	1	40 kg
DQC651	S-30/150	0,5-2	Hydraulic	40°+40°	1	40 kg
DQC652	S-30/180	0,5-2	Mechanical	40°+40°	1	40 kg
DQC653	S-30/180	0,5-2	Hydraulic	40°+40°	1	40 kg
DQC654	S-40	2-5	Mechanical	37°+37°	1	85 kg
DQC655	S-40	2-5	Hydraulic	37°+37°	1	90 kg
DQC664	S-45	5-12	Mechanical	37°+37°	1	180 kg
DQC665	S-45	5-12	Hydraulic	37°+37°	1	190 kg
DQC656	S-50	5-13	Mechanical	37°+37°	1	180 kg
DQC657	S-50	5-13	Hydraulic	37°+37°	1	190 kg
DQC658	S-60	12-18	Mechanical	37°+37°	2	280 kg
DQC659	S-60	12-18	Hydraulic	45°+45°	2	510 kg
DQC661	S-70	17-25	Hydraulic	45°+45°	2	625 kg
DQC667	Komatsu WB97-5	5-12	Mechanical	37°+37°	1	75 kg
DQC647	JCB130	12-18	Hydraulic	45°+45°	2	450 kg
DQC648	JCB160	-	Hydraulic	45°+45°	2	490 kg
DQC649	JCB200	16-24	Hydraulic	45°+45°	2	545 kg



Quick couplers

Code	Coupler	Locking system	Reccomended machine weight (t)	Weight
SQC601	NTP10	Mechanical	13-22	210 kg
SQC602	NTP10	Hydraulic	13-22	240 kg
SQC603	NTP20	Mechanical	18-29	245 kg
SQC604	NTP20	Hydraulic	18-29	280 kg
SQC605	NTP30	Mechanical	18-29	-
SQC606	NTP30	Hydraulic	18-29	315 kg
SQC607	NTP40	Mechanical	25-40	-
SQC608	NTP40	Hydraulic	25-40	510 kg



Code	Coupler	Locking system	Reccomended machine weight (t)	Weight
SQC620	S-30/150	Mechanical	0,5-2	20 kg
SQC621	S-30/150	Hydraulic	0,5-2	20 kg
SQC622	S-30/180	Mechanical	0,5-2	20 kg
SQC623	S-30/180	Hydraulic	0,5-2	20 kg
SQC624	S-40	Mechanical	2-5	40 kg
SQC625	S-40	Hydraulic	2-5	45 kg
SQC634	S-45	Mechanical	5-12	60 kg
SQC635	S-45	Hydraulic	5-12	65 kg
SQC626	S-50	Mechanical	5-13	60 kg
SQC627	S-50	Hydraulic	5-13	65 kg
SQC628	S-60	Mechanical	12-18	125 kg
SQC629	S-60	Hydraulic	12-18	165 kg
SQC631	S-70	Hydraulic	17-25	270 kg
SQC633	S-80	Hydraulic	25-40	430g
SQC610	JCB130	Hydraulic	12-18	160 kg
SQC636	JCB200	Hydraulic	16-24	290 kg
SQC640	JCB330	Hydraulic	24-35	450 kg
SQC637	Komatsu WB93...97/5	Mechanical	5-12	50 kg
SQC638	Hidromek 102B-S	Hydraulic	5-12	70 kg



Adapters

Code	Coupling	Coupler	Weight
ADP45	NTP10	S-45	200 kg
ADP54	NTP10	S-60	230 kg
ADP50	NTP20/NTP30	NTP10	315 kg
ADP51	NTP10	NTP20/NTP30	315 kg
ADP52	NTP40	NTP20/NTP30	520 kg
ADP65	S-45	NTP10	170 kg
ADP67	S-60	NTP10	200 kg
ADP68	S-70	NTP10	350 kg

Code	Machine weight
ADP53	1,5...45 t



Couplings

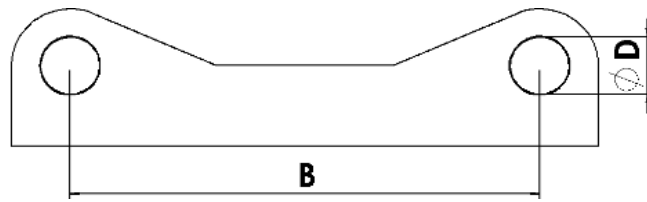
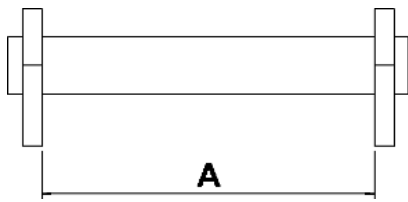

Code	Coupling	A (mm)	B (mm)	D (mm)	Weight
CP0031	S-30/150	150	200	30	5 kg
CP0032	S-30/180	180	230	30	6 kg
CP0040	S-40	200	300	40	11 kg
CP0045	S-45	290	430	45	17 kg
CP0050	S-50	270	430	50	17 kg
CP0060	S-60	340	480	60	50 kg
CP0070	S-70	450	600	70	70 kg
CP0080	S-80	590	670	80	116 kg

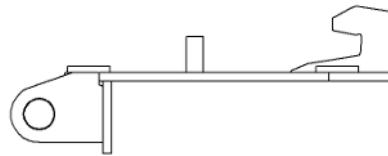
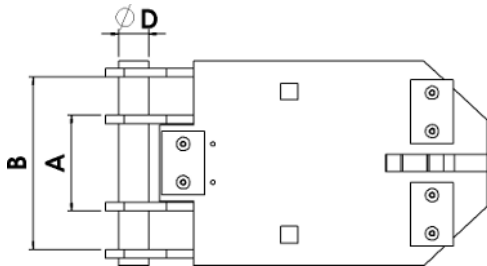

Code	Coupling	A (mm)	B (mm)	D (mm)	Weight
CP010	NTP10	225	405	70	105 kg
CP020	NTP20	305	485	80	130 kg
CP030	NTP30	350	525	80	150 kg
CP040	NTP40	340	632	100	375 kg
CP011	Länner	245	345	50	-

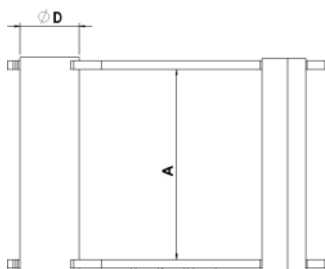

Code	Coupling	D (mm)	A (mm)
GJ300	GJ300	95	305
GJ500	GJ500	132	502



Asphalt cutters

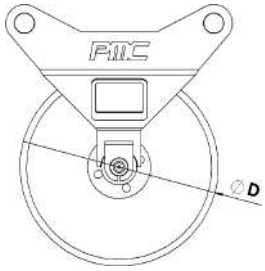

Code	Coupling	Diameter (mm)	Weight
ASC900/150	S-30	300	25 kg
ASC900/180	S-30	300	25 kg
ASC901	S-40	400	40 kg
ASC906	S-40	300	40 kg
ASC902	S-45	450	60 kg
ASC909	S-50	450	60 kg
ASC903	S-60	450	75 kg
ASC910	S70	450	130 kg
ASC907/1	Attaches to wear plate	400	70 kg
ASC907/2	Attaches to wear plate	450	70 kg
ASC908	GJ300	400	60 kg
ASC911	GJ500	450	135 kg

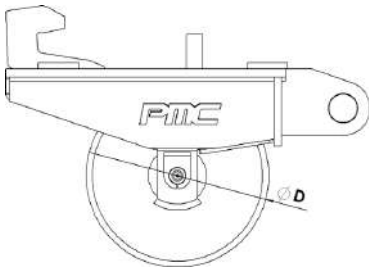

Code	Coupling	Diameter (mm)	Weight
ASC904	NTP10	450	175 kg
ASC905	NTP20	450	210 kg



Forklifts

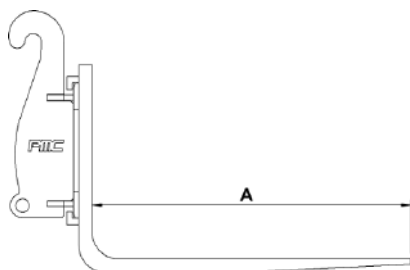

Code	A (mm)	Width (mm)	Adjustable	Capacity (kg)	Comment
FL1002	1200	1500	Mechanical	1000 - 2500	FEM 2
FL1003	1200	1500	Mechanical	2501 - 4999	FEM 3
FL1004	1200	1500	Mechanical	5000 - 10000	FEM 4
FL1009	1200	2000	Hydraulic	6000	Weight 700 kg
FL1015	1200	1500	Mechanical	3000	S-45 coupler
FL1016	1200	1500	Mechanical	5000	S-60 coupler
FL1017	1200	1500	Mechanical	5000	S-70 coupler
FL1018	1200	1500	Mechanical	5000	SMP2 & NTP coupler
FL1019	1200	2500	Hydraulic	6000	Weight 780 kg

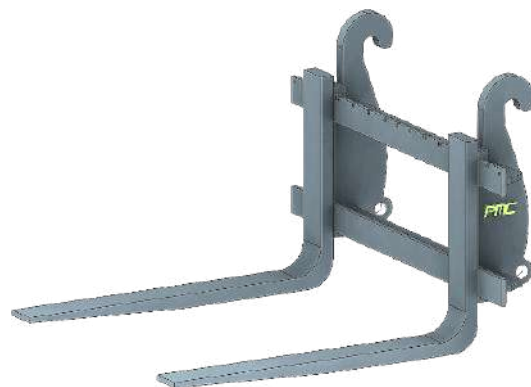
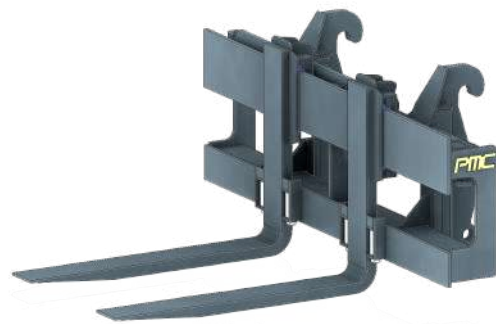

Bag lifters

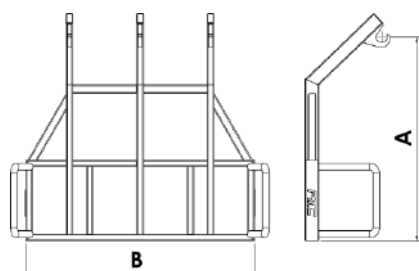

Code	Hooks	A (mm)	B (mm)	Capacity
BL1010	1	1500	1100	1250 kg
BL1011	2	1500	1400	2 x 1250 kg
BL1012	3	1500	1700	3 x 1250 kg



Lifting booms

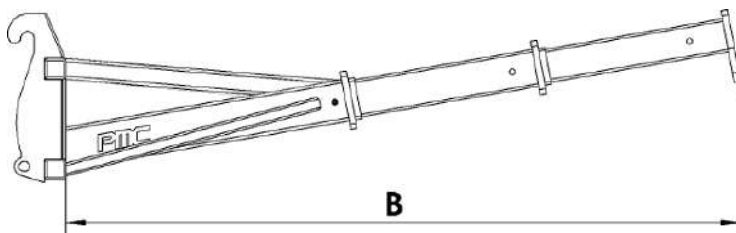
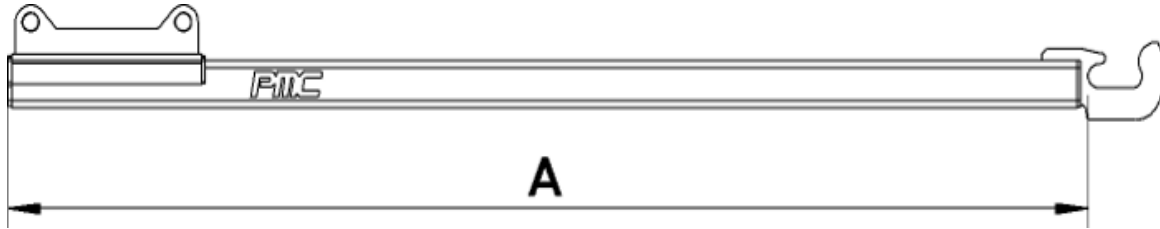
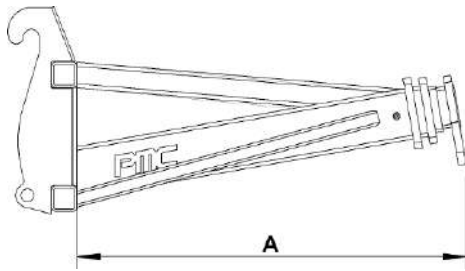

Code	A (mm)	B (mm)	Adjustable	Capacity (t)	Weight	Comments
LB1004	3000	-	-	0,5	120	For excavators
LB1005	3000/4000	-	-	2,5	410	For excavators
LB1007	1850	4250	Mechanical	0,5-2,5	320	For loaders
LB1008	1500	3150	Mechanical	3-10	385 kg	For loaders
LB1020	1690	-	-	1	155 kg	For loaders
LB1020H	1750	2400	Hydraulic	1	240 kg	For loaders
LB1025	2080	-	-	-	175	For loaders

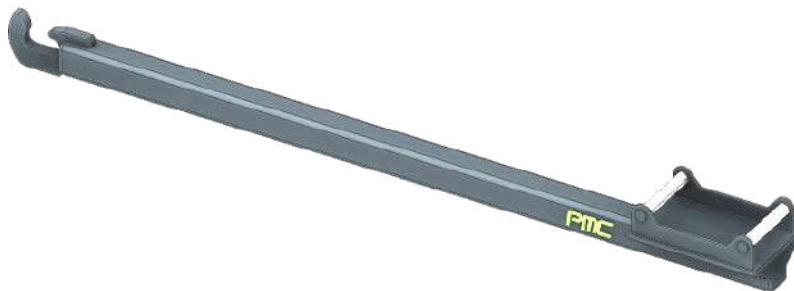

Ranger hook

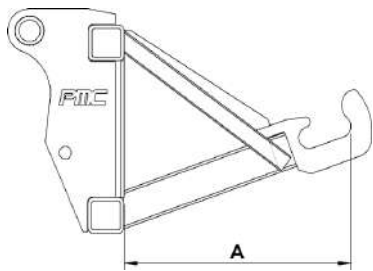

Code	A (mm)	Capacity (t)
RH120	630	5



Digging bucket thumb

Code	Comment
DBT	Ask for suitability



Hooks

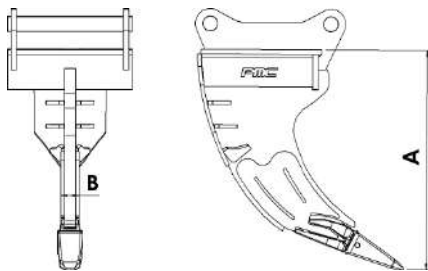

Code	Machine weight	A (mm)	B (mm)	Adaper	Weight
HO709	1,5-2,5	520	50	J200	40 kg
HO700	2,5-5	760	64	J250	100 kg
HO701	5-10	965	64	J250	135 kg
HO702	11-16	805	92	J350	325 kg
HO703	18-21	970	92	J350	430 kg
HO704	22-24	1065	100	J450	500 kg
HO705	25-28	1220	100	J550	690 kg
HO706	28-45	1255	160	J600	1050 kg



Stub crushers

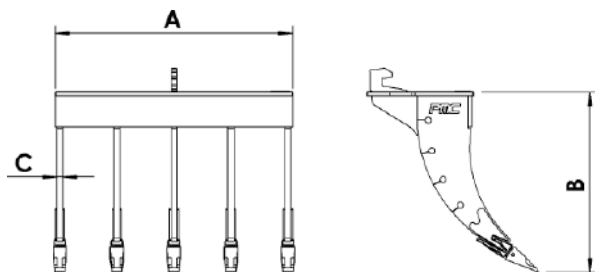

Code	Hooks (pcs)	A (mm)	B (mm)	C (mm)	Weight	Comments
SBC706	4	1000	750	30	280 kg	Without teeth
SBC707	3	1000	1065	40	520 kg	J300 adapters
SBC710	4	1175	1165	40	650 kg	J300 adapters
SBC711	12	1155	700	12	220 kg	Without teeth
SBC712	13	1100	560	10	160 kg	Without teeth
SBC713	5	1500	1170	40	810 kg	J300 adapters
SBC714	7	2280	1150	40	1140 kg	J300 adapters

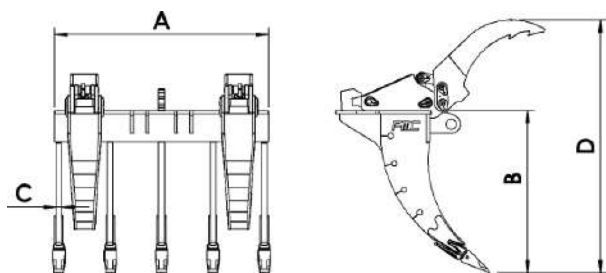

Code	Hooks (pcs)	A (mm)	B (mm)	C (mm)	D (mm)	Weight	Comments
SBC-GR	5	1540	1170	40	1830	1075 kg	J300 adapters



Cable ploughs

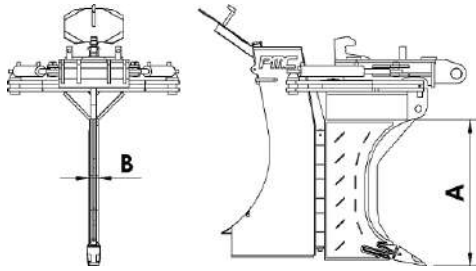

Code	A (mm)	B, max cable diameter (mm)	Weight	Comments
CPL800	1000	40	870 kg	32°+32° turnable
CPL801	1300	60	900 kg	32°+32° turnable
CPL802	1300	120	1230 kg	32°+32° turnable
CPL804	1400	60	900 kg	32°+32° turnable
CPL810	1000	50	550 kg	Rigid
CPL812	1200	100	960 kg	Rigid
CPL814	1400	120	1050 kg	Rigid



Energy wood grapple

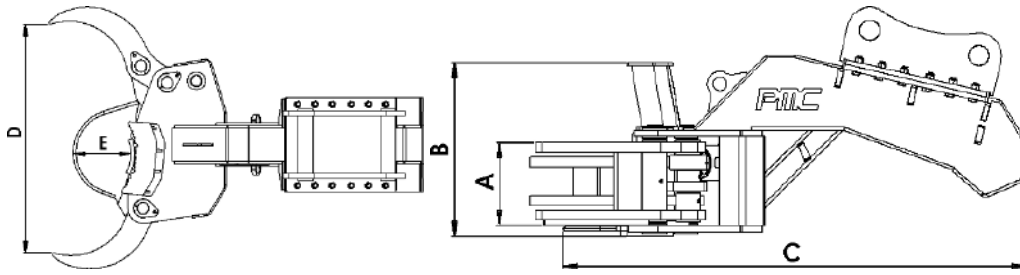

Code	Reccomended machine weight	Max cutting diameter (mm)	A (mm)	B (mm)	C (mm)	D (mm)	E (mm)	Weight
EWG120	8-12t	200	260	595	1290	1230	305	450 kg
EWG130	13-16t	250	325	680	1560	1230	305	680 kg
EWG140	16-21t	300	425	790	1880	995	305	800 kg



Grain pusher

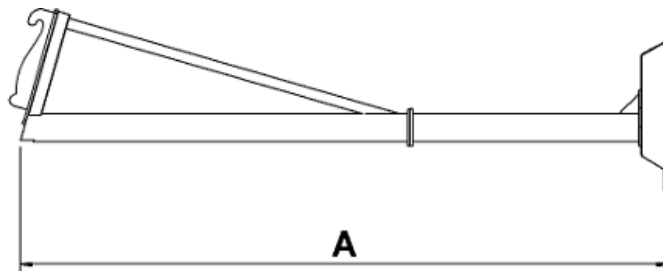
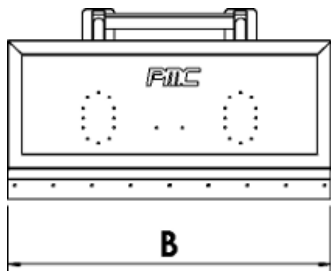

Code	A (mm)	B (mm)	Weight
GP2500	3000	2500	790 kg
GP-10M	10000	2500	1500 kg

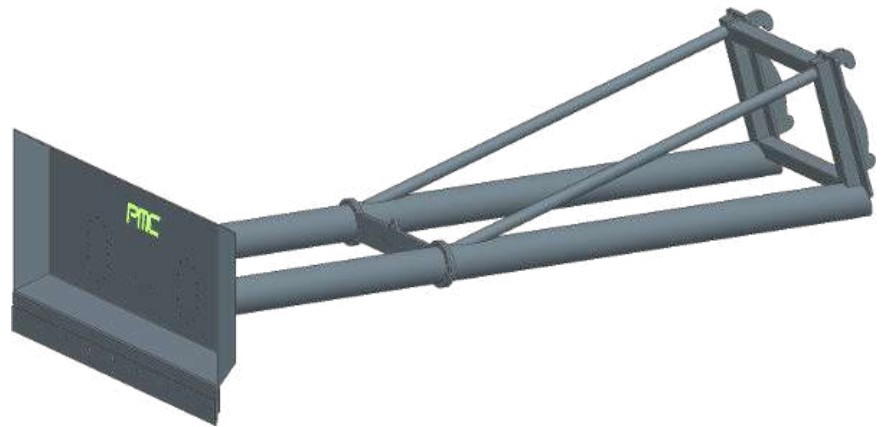

Sweepers

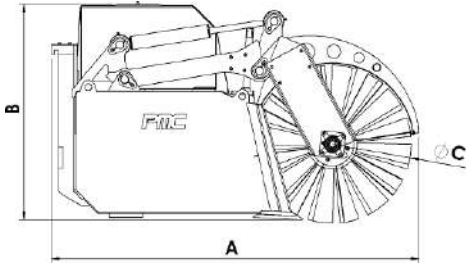

Code	A (mm)	B (mm)	C (mm)	Width (mm)	Bucket capacity	Tank capacity	Weight
SWB1600	1550	875	700	1600	530L	145L	600 kg
SWB1800	1550	875	700	1800	600L	145L	660 kg
SWB2000	1635	930	700	2000	760L	300L	715 kg
SWB2500	1845	890	700	2500	960L	2 x 190L	720 kg
SWB2500XL	2070	1010	900	2500	1550L	2 x 190L	900 kg
SWB3000	2070	1010	900	3000	1800L	2 x 190L	1120 kg

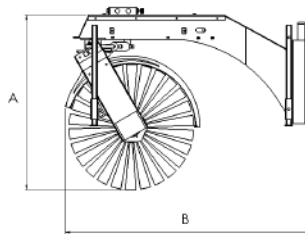
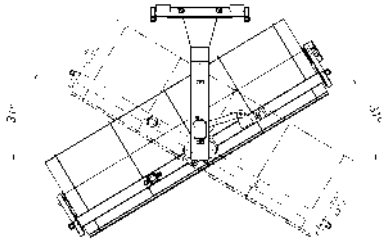
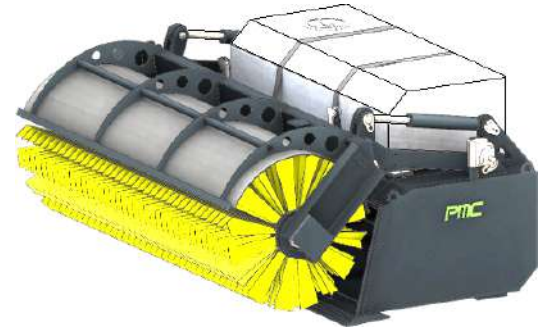

Code	Width (mm)	A (mm)	B (mm)	Turning angle	Tank capacity	Weight	Comments
FLB2000	2000	1115	1545	31°+31°	250	400 kg	Brush diameter 700mm
FLB2500	2500	1115	1765	31°+31°	250	565 kg	Brush diameter 700mm
FLB3000	3000	1315	1765	31°+31°	250	605 kg	Brush diameter 900mm

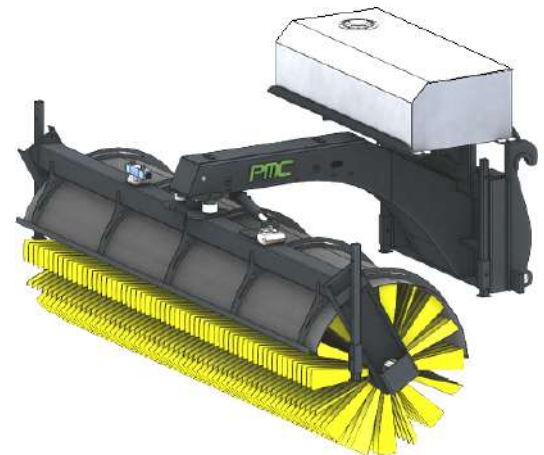

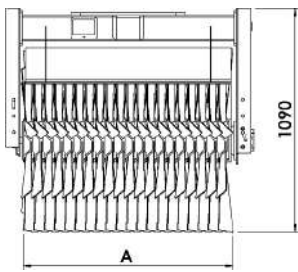

Code	A (mm)	Weight	Comments
EXB600	600	-	Brush diameter 900 mm
EXB1000	1000	170 kg	Brush diameter 900 mm
EXB1500	1500	200 kg	Brush diameter 900 mm
EXB2000	2000	250 kg	Brush diameter 900 mm
EXB2500	2500	300 kg	Brush diameter 900 mm

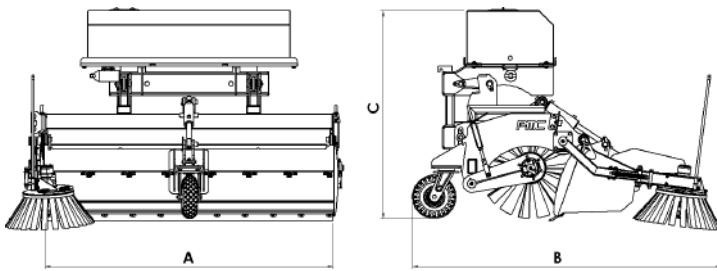

Code	Width (mm)	Capacity	A (mm)	B (mm)	C (mm)	Water tank	Comments
FSW2000	1995-2340	200 L	1995	2200	1470	300 L	Can be used with forklifts

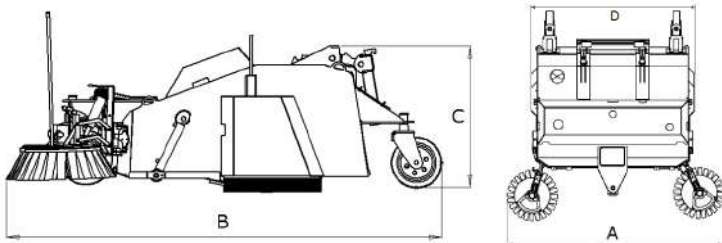

Code	Width (mm)	Capacity	A (mm)	B (mm)	C (mm)	D (mm)	Weight	Water tank	Comments
CSW1700	1700	400 L	1900-2900	3000	1060	1890	1300 kg	320 L	Lamella 900
CSW2300	2300	650 L	2500-3500	3100	1060	2500	1800 kg	425 L	Lamella 900



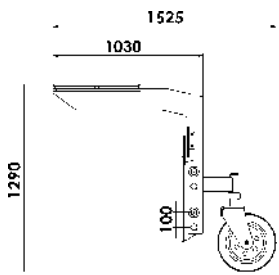

Code	Weight	Turning radius	Comments
SWB-RS	450 kg	180°	Rotating and Floating system for SWB



Code	Weight	Comments
SWB-SB	70 kg	Side brush for SWB

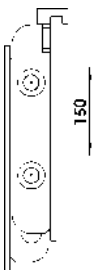

Code	Weight	Comments
SWB-FS	215 kg*	Floating system for SWB

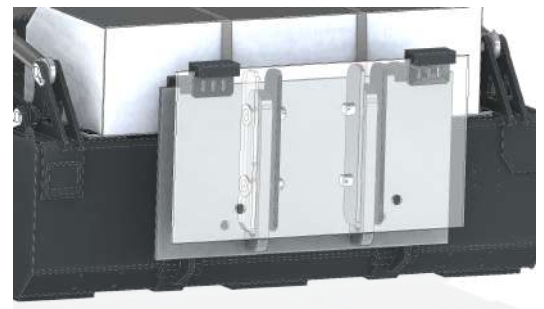

Zoom ploughs

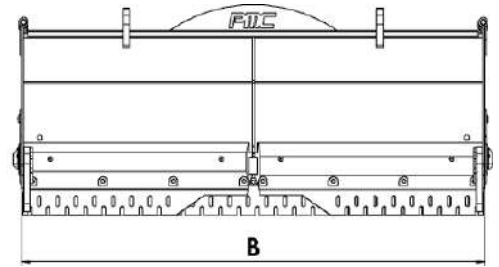
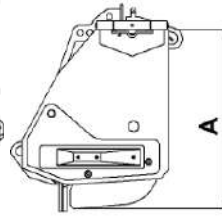
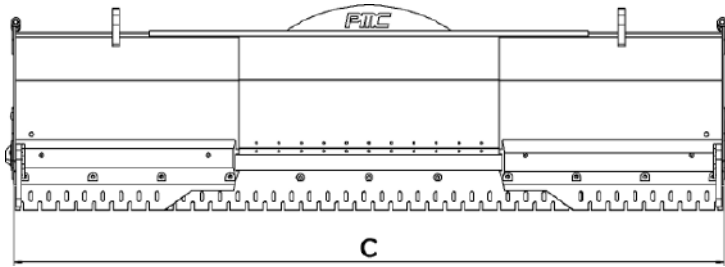

Code	A (mm)	B (mm)	C (mm)	Turning angle	Weight
SZ1450	600	1450	2350	30°+30°	495 kg
SZ1700	790	1700	2700	30°+30°	840 kg
SZ2000	790	2000	3200	30°+30°	875 kg
SZ2500	790	2500	4000	30°+30°	1025 kg
SZ2700	950	2700	4400	30°+30°	1180 kg



U-ploughs

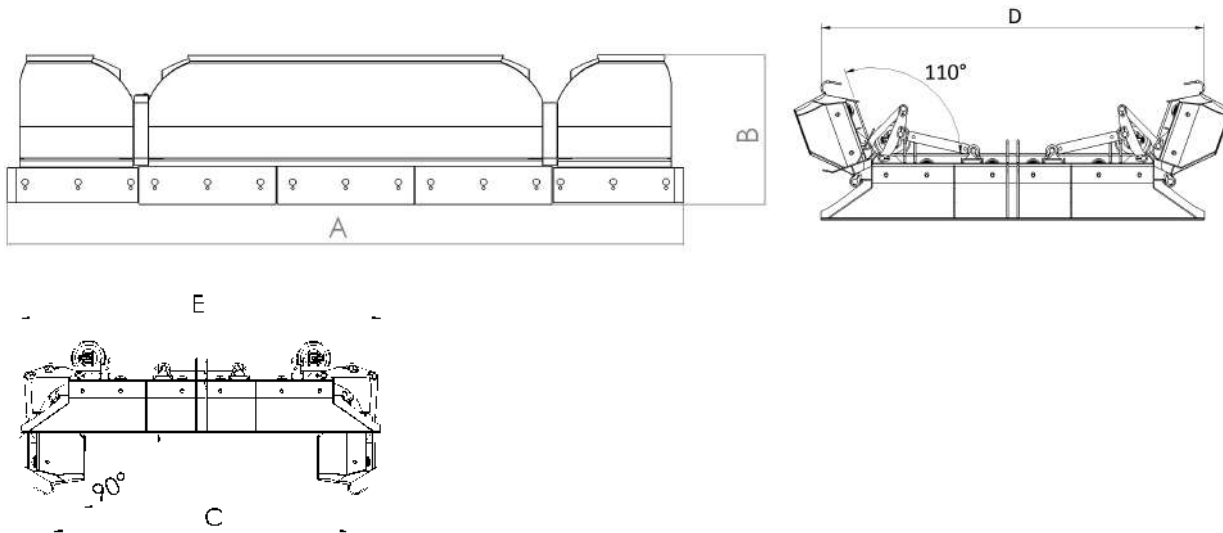

Code	A (mm)	B (mm)	C (mm)	D (mm)	E (mm)	Weight
UPL2000	3500	850	2100	2640	2580	850 kg
UPL2400	3900	850	2400	2860	2880	950 kg
UPL2400	4300	850	2400	2980	2880	1050 kg
UPL2800	4300	1100	2800	3210	3220	1250 kg
UPL2800	4700	1100	2800	3330	3270	1280 kg
UPL3000	6100	1300	3000	4950	3535	1785 kg
UPL4000	6000	1300	4000	5300	4540	1785 kg

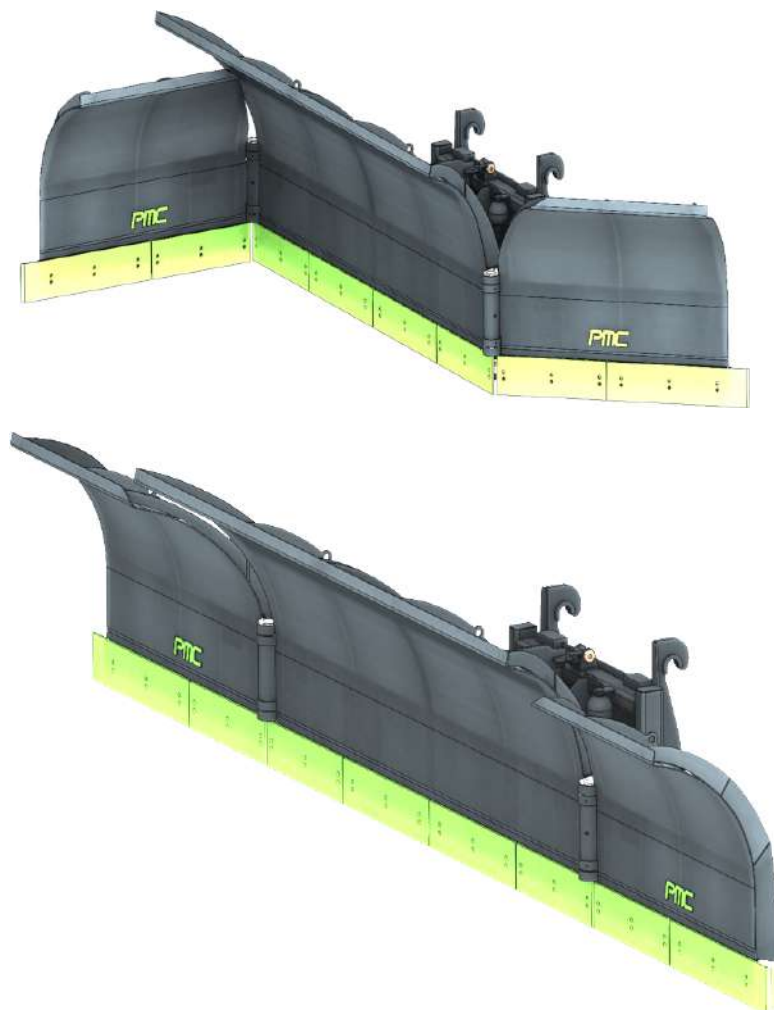

V-ploughs

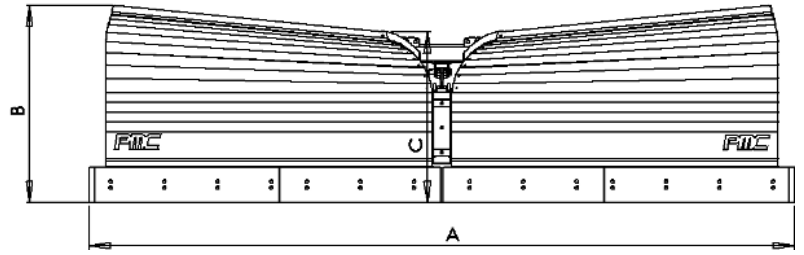
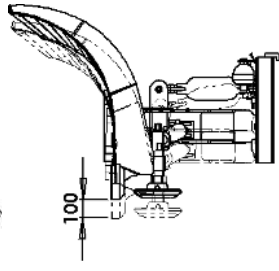
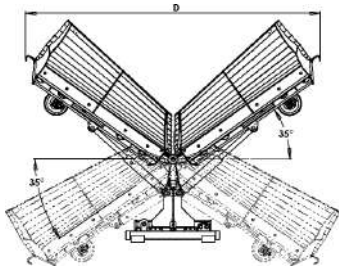

Code	A (mm)	B (mm)	C (mm)	D (mm)	Weight
VPL1800	1800	750	650	1560	345 kg
VPL2000	2000	750	650	1750	420 kg
VPL2300	2300	850	740	1990	545 kg
VPL2500	2500	850	740	2170	630 kg
VPL2700	2700	850	740	2340	-
VPL2900	2900	850	740	2500	690 kg
VPL3300	3300	1000	850	2860	760 kg
VPL3700	3700	1100	950	3200	890 kg
VPL4000	4000	1100	950	3470	950 kg

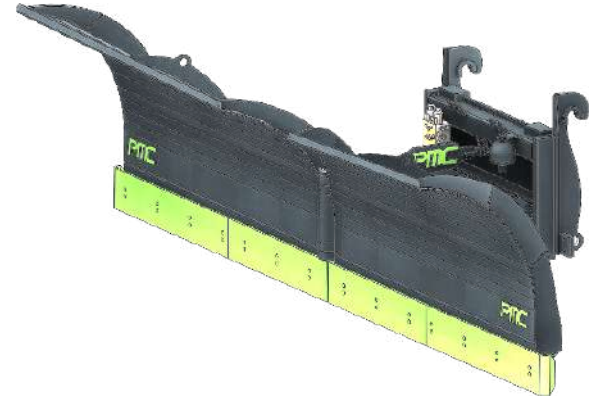

Road snow ploughs

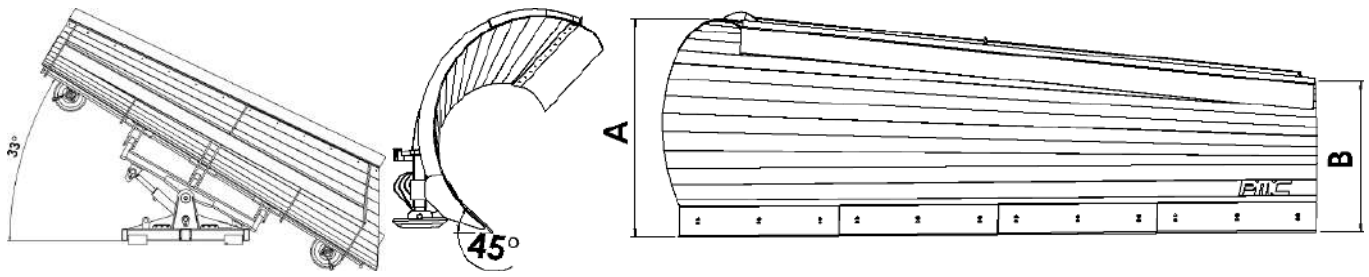

Code	A (mm)	B (mm)	C (mm)	Width (mm)	Turning angle	Weight
RSP2800	1200	700	2350	2800	27°+33°	825 kg
RSP3200	1200	700	2685	3200	27°+33°	840 kg
RSP3600	1300	700	3100	3700	27°+33°	1025 kg
RSP4300	1200	865	3700	4280	30°+30°	1100 kg



Straight snow ploughs

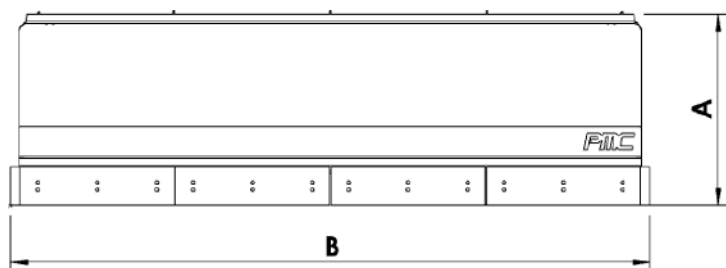

Code	A (mm)	B (mm)	Turning angle	Weight
SPL518	600	1950	30°+30°	330 kg
SPL514	900	3000	30°+30°	540 kg
SPL519	900	2500	30°+30°	480 kg
SPL512	995	2200	30°+30°	-
SPL511	995	2500	30°+30°	-
SPL513	995	2900	30°+30°	710 kg
SPL515	995	3300	30°+30°	830 kg
SPL516	995	3700	30°+30°	-
SPL517	995	4000	30°+30°	760 kg



Multi purpose snow buckets

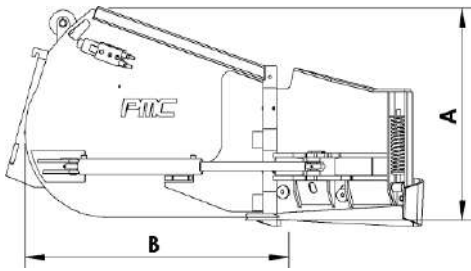

Code	Capacity	A (mm)	B (mm)	Width (mm)	Weight
MSB140	500 L	755	855	1400-2560	290 kg
MSB170	1000 L	820	995	1700-3170	655 kg
MSB200	1500 L	960	1160	2000-3470	630 kg
MSB230	2000 L	960	1160	2300-3770	675kg
MSB250	2000 L	960	1160	2500-3970	685 kg
MSB270	4000 L	1400	1550	2700-4700	1360 kg
MSB290	4500 L	1400	1550	2900-4900	1440 kg



Sand spreading buckets

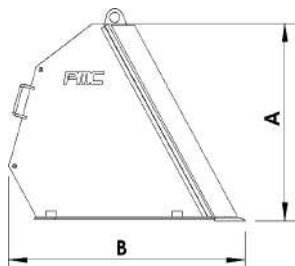

Code	Capacity	A (mm)	B (mm)	Spreading width (mm)	Weight
SSB400	400 L	580	1100	1100	250 kg
SSB600	500 L	580	1100	1400	310 kg
SSB700	900 L	975	1165	1400	415 kg
SSB1000	1000 L	975	1165	1600	450 kg
SSB1500	1300 L	980	1215	2000	620 kg
SSB2000	1400 L	980	1215	2200	835 kg
SSB2500	2100 L	1175	1450	2200	930 kg
SSB3000	3000 L	1175	1450	2700	1240 kg

